



807003 - 807006

RING POLE MAXI

Floodlight for outdoor installation on a pole diam. 60 mm or 76 mm, with 355° swivel pole attachment and allowing horizontal adjustment of +90° / -40°. Phosphochromatised and polyester powder coated die-cast copper-free aluminium base and head, tempered safety glass, moulded silicone gaskets and o-rings, with screws in stainless steel. Swivel pole joint with graduated scale and mechanical aiming lock. Built-in LED driver, with 1 COB CREE "CXB 2540" LED. IP66 rating.

807003

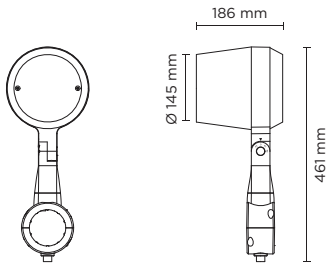

807006

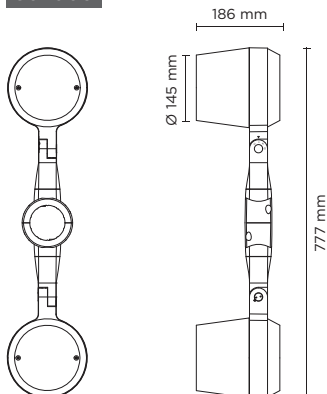

Technical features









Technical data

IP Rating	IP66
IK Rating	IK08
Material	High corrosion resistance die-cast copper-free aluminum body
Coating	Polyester powder coating with phosphochromating pre-finish
Screws	Stainless steel
Transformer	Electrical power supply 220/240V 50/60Hz built-in
Gasket	Silicone rubber
Glass	Tempered
Cable gland	M16 rubber grommet
Power cable	Not included



LAREN O

807003		SINGLE RING POLE MAXI - 42 WATT 220-240V 50-60HZ		
light source	light beam options	lumen output (lm)	lumin. efficacy (lm/w)	
3000°K warm-white				
cob led	 14°	4.950	117.85	
cob led	 35°	4.752	113.14	
cob led	 55°	4.560	108.57	
4000°K neutral-white				
cob led	 14°	5.265	125.36	
cob led	 35°	5.000	119.05	
cob led	 55°	4.770	113.57	







Colors options

-  Textured Grey RAL 9006
-  Anthracite Grey RAL 7016
-  Matt Black (on request)

Technical data

Wattage	42 WATT
Light source	1 COB CREE "CXB 2540" LED
Gross weight	4,50 Kg



807006		DOUBLE RING POLE MAXI - 2X42 WATT 220-240V 50-60HZ		
light source	light beam options	lumen output (lm)	lumin. efficacy (lm/w)	
3000°K warm-white				
cob led	 14°	2 x 4.950	117.85	
cob led	 35°	2 x 4.752	113.14	
cob led	 55°	2 x 4.560	108.57	
4000°K neutral-white				
cob led	 14°	2 x 5.265	125.36	
cob led	 35°	2 x 5.000	119.05	
cob led	 55°	2 x 4.770	113.57	

Colors options

-  Textured Grey RAL 9006
-  Anthracite Grey RAL 7016
-  Matt Black (on request)

Technical data

Wattage	2X42 WATT
Light source	2 COB CREE "CXB 2540" LED
Gross weight	8,50 Kg



POLES & ACCESSORIES

Full technical details of poles and accessories for poles are available at the end of the catalogue

BURIED POLES	
code	h. mm.
809901	3.500
809902	4.500
809903	5.500
809908	ACC.

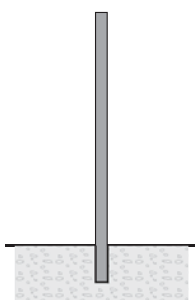

POLES WITH BASE-PLATE	
code	h. mm.
809904	3.000
809905	4.000
809906	5.000
809907	ACC.
809908	ACC.

